

# **Inrush-Limiter T1**

Transformer inrush current limiter

## Product Specifications

Model Number: T1-210

## Contents

|   |           |
|---|-----------|
| <b>Chaptear 1. Product Overview .....</b>                     | <b>3</b>  |
| 1- 1 Scope.....   | 3         |
| 1-2 Functional Overview.....                                  | 3         |
| 1-3 Product Features.....                                     | 3         |
| 1-4 Control Block Diagram .....                               | 4         |
| 1-5 Functions.....  | 4         |
| <b>Chaptear 2. Descriptions of Each Part .....</b>            | <b>5</b>  |
| 2- 1 Control Unit (Product No.: IL-CU210).....                | 5         |
| 2- 2 I/O Unit (Product No.: IL-IO-DC110) .....                | 6         |
| <b>Chaptear 3. Control Functions .....</b>                    | <b>7</b>  |
| 3- 1 Timing Chart.....  | 7         |
| 3- 2 Re-energizing Operation of the Transformer.....          | 8         |
| 3- 3 Shutdown Operation of the Transformer .....              | 8         |
| 3- 4 Source Failure Protection (Optional).....                | 9         |
| <b>Chaptear 4. Product Specifications.....</b>                | <b>10</b> |
| <b>Chaptear 5. I/O specifications .....</b>                   | <b>11</b> |
| 5- 1 Input Terminals (TB1) Mounted on the Control Unit .....  | 11        |
| 5- 2 Input Terminals (X1) Mounted on the Operation Unit.....  | 12        |
| 5- 3 Output Terminals (X2) Mounted on the Operation Unit..... | 13        |
| <b>Chaptear 6. Standard Cabinet Specifications.....</b>       | <b>14</b> |
| <b>Chaptear 7. PC for Maintenance and Indicators .....</b>    | <b>15</b> |
| 7- 1 PC for Maintenance .....                                 | 15        |
| 7- 2 Touch panel .....  | 16        |

|  |           |
|--|-----------|
| <b>Chaptear 8. Installation Notes .....</b>            | <b>17</b> |
| 8- 1 Mounting Dimensions and Panel Cutouts .....       | 17        |
| 8- 2 Construction .....                                | 17        |
| 8- 3 Wiring .....                                      | 18        |
| 8- 4 Inspections .....                                 | 18        |
| <b>Chaptear 9. Testing and Adjustments .....</b>       | <b>19</b> |
| <b>Chaptear 10. Maintenance .....</b>                  | <b>20</b> |
| 10- 1 Daily Inspections .....                          | 20        |
| 10- 2 Regular Inspections .....                        | 20        |
| 10- 3 Consumables .....                                | 20        |
| 10- 4 Notice .....                                     | 20        |
| <b>Chaptear 11. Options .....</b>                      | <b>21</b> |
| 11- 1 Product Options.....                             | 21        |
| 11- 2 Service Options.....                             | 21        |
| 11- 3 Functional Options .....                         | 21        |
| <b>Chaptear 12. Others .....</b>                       | <b>22</b> |
| 12- 1 Warranty.....                                    | 22        |
| 12- 1 Notes on Specifications.....                     | 22        |
| <b>Chaptear 13. Typical Application Procedure.....</b> | <b>23</b> |

### Chapter 1. Product Overview

#### 1-1 Scope

This document describes the specifications for the Inrush-Limiter T1-200 (hereafter, "the Inrush Limiter"), a device that suppresses the inrush current that occurs when a transformer is energized.

#### 1-2 Functional Overview

The Inrush Limiter minimizes the inrush current that occurs when a transformer is energized, which thereby reduces undesirable effects such as voltage drop and waveform distortion.

The Inrush Limiter uses phase angle control. It references the transient voltage in the transformer that occurs when the transformer is shutdown. A proprietary algorithm is used to calculate the residual flux in the transformer core to determine the controlled reference phase at which to close the breaker.

The breaker closes to re-energize the transformer when the source voltage reaches the phase angle that was determined earlier, thus suppressing inrush current.

#### 1-3 Product Features

The Inrush Limiter has the following features.

##### **Excellent Control Performance**

- The Inrush Limiter receives a control signal from the main control panel (main panel), and in turn, automatically finds the optimum timing at which to close breaker to suppress inrush current.
- The operation of closing and tripping the breaker on the main utility cabinet is the same whether the Inrush Limiter is used or not.

##### **Compact Design, Ideal Serviceability**

- The Inrush Limiter features a compact, solid-state design that lends itself to either new or existing systems.
- The only connections with the main utility cabinet are the secondary VT voltages, circuit breaker control signal, and outputs such as for alarms.
  - \*No CT input necessary.
- No daily maintenance.

##### **Fail-safe Design and Data Logging**

- The Inrush Limiter controls only the timing at which the breaker is closed. It does not interfere with the Closing or Tripping controls on the main utility cabinet.
- Various data, such as the residual flux and voltage drop when the transformer is shutdown or re-energized, are shown in display with touch-panel on the front panel. You can connect a PC for maintenance to view a data log of up to 100 trip/close events.

### 1-4 Control Block Diagram

The following diagram shows the control blocks of the Inrush Limiter.

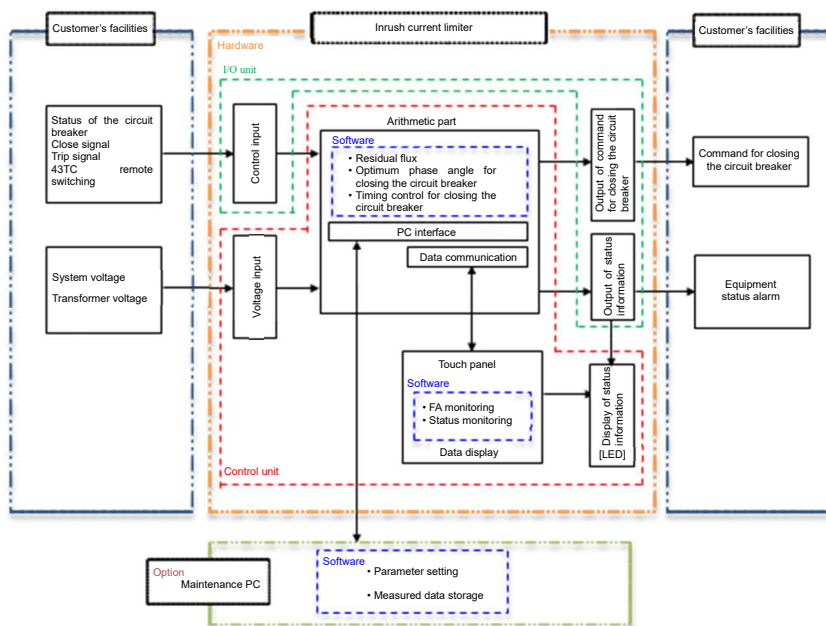

### 1-5 Functions

The functions for each part are shown below.

| # | Item  | Function   |
|---|---|--|
| 1 | Voltage input                                     | The secondary voltage of the VT for the system voltage (primary side of the circuit breaker for the primary side of the transformer) and transformer voltage (primary or secondary side of the transformer) is input to the control unit via an input converter. |
| 2 | Control input                                     | Receives an external control signal and inputs it into the control unit.   |
| 3 | Output of command for closing the circuit breaker | Receives a command for closing the circuit breaker from the control unit and outputs it to the external device (circuit breaker).  |
| 4 | Output of status information                      | Outputs information about unit status and alarms to external devices.  |
| 5 | Display of status information                     | Displays information about unit status and alarms.   |
| 6 | Touch panel                                       | Displays information about operation history of a circuit breaker and alarm monitoring.  |
| 7 | Arithmetic part                                   | Performs arithmetic operation and control. It consists of a power unit, CPU unit, DIO unit and A/D unit.   |
| 8 | Maintenance PC                                    | It provides a LAN connection to a PC intended for adjusting the interface with the controller and maintenance work.  |

### Chapter 2. Descriptions of Each Part

The Inrush Limiter has a Control Unit (Model No: IL-CU210) that performs calculations, and an I/O Unit (Model No.: IL-IO-DC110) that has various switches and indicators.

#### 2- 1 Control Unit (Product No.: IL-CU210)

The Control Unit is shown below along with names and functional descriptions.

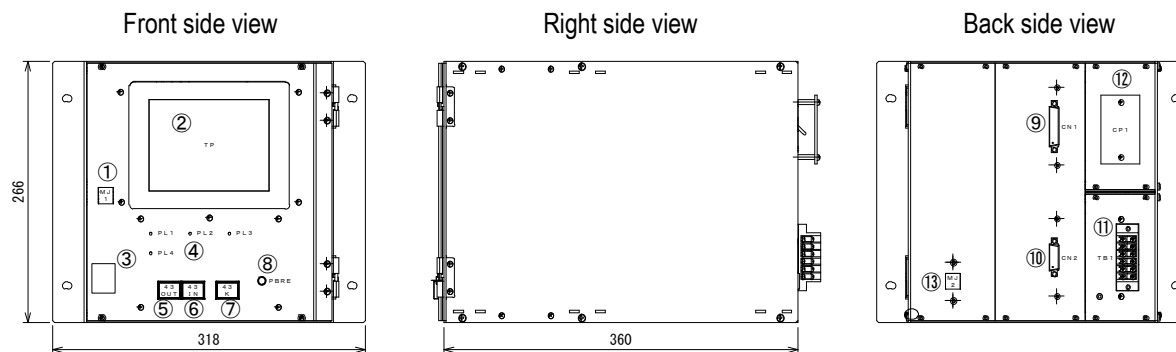

| No.  | Part Name                                | Function   |
|------|--|--|
| (1)  | LAN1                                     | Connection to a PC that has been installed with the Software Tool*.<br>※ The Software Tool allows the following operations and settings. <ul style="list-style-type: none"> <li>• Log viewing for up to 100 events when the transformer was shutdown or re-energized, and waveforms for voltage drops.</li> <li>• Settings (frequency, transformer specifications, etc.) that are necessary for the Inrush Limiter to function.</li> <li>• Settings for manual control.</li> </ul> |
| (2)  | Touch panel                              | Displays the actual data (operating time and phase angle for closing the breaker) and voltage drop levels when the circuit breaker was closed.   |
| (3)  | Production Nameplate                     | Shows the product name, the model code, input specifications, and date of manufacture.   |
| (4)  | Status and Alarm Indicators              | Show that state of the control power, circuit breaker, and whether control is enabled (ready completed), as well as any alarms with the equipment.   |
| (5)  | 43TC Lock Illuminated Pushbutton Switch  | For disable the control of the Inrush Limiter.   |
| (6)  | 43TC Use Illuminated Pushbutton Switch   | For enable the control of the Inrush Limiter.  |
| (7)  | Write Lock Illuminated Pushbutton Switch | For disables/enables data writing.   |
| (8)  | Alarm Reset Button                       | For resets the alarm display.  |
| (9)  | Signal Connector (25P)                   | For the digital I/O signals between the Control and I/O units.   |
| (10) | Signal Connector (15P)                   | For the digital I/O signals between the Control and I/O units.   |
| (11) | Connector-type Terminals                 | Connection for external input signals. The connections are made through a connector.   |
| (12) | Control Power Switch                     | For power to the Control units.  |
| (13) | LAN2                                     | Maintenance for LAN. Manufacture use only.   |

2-2 I/O Unit (Product No.: IL-IO-DC110)

The Operations Unit is shown below along with names and functional descriptions.

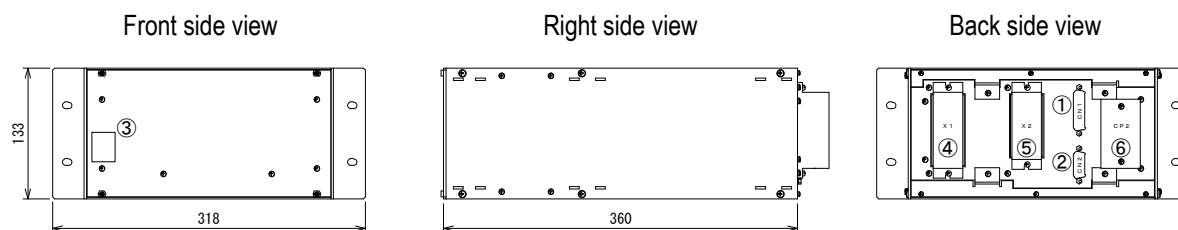

| No. | Part Name                      | Function   |
|-----|--------------------------------|--|
| (1) | Signal Connector (25P)         | For the digital I/O signals between the Control and I/O units.   |
| (2) | Signal Connector (15P)         | For the digital I/O signals between the Control and I/O units.   |
| (3) | Production Nameplate           | Shows the product name, the model code, input specifications, and date of manufacture.                 |
| (4) | Connector-type Terminals (14P) | Connection for external input signals. The connections are made through a connector.                   |
| (5) | Connector-type Terminals (12P) | Connection for power supply and external output signals. The connections are made through a connector. |
| (6) | Control Power Switch           | For power to the I/O units.  |

Chaptear 3. Control Functions

3- 1 Timing Chart

The following chart shows the timing at which the transformer re-energizes/shuts down based on the manual circuit breaker trip/close signals from the power utility substation equipment.

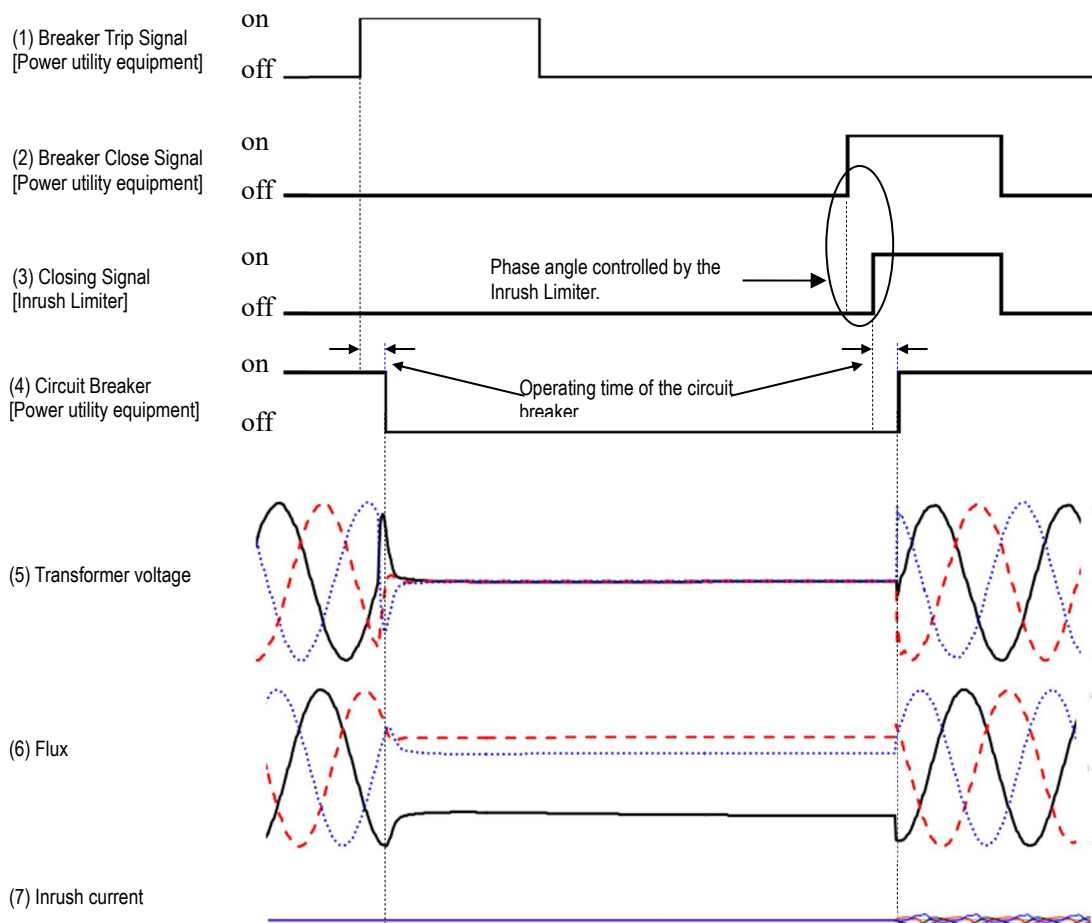

Transformer Shutdown

- 1). Manually trip the circuit breaker on the power utility substation equipment (circuit breaker control panel) to shutdown the transformer.
- 2). The Controller receives the (1) Breaker Trip Signal and trips the (4) Circuit Breaker which stops the (5) transformer voltages.
- 3). The (6) fluxes are calculated from the (5) transformer voltage waveforms before and after the shutdown.
- 4). The (6) fluxes are used to calculate the reference phase at which to close the breaker the next time the transformer is to be re-energized.

Transformer Re-energize

- 1). Manually close the circuit breaker on the power utility substation equipment (circuit breaker control panel) to re-energize the transformer
- 2). (2) The Controller receives the (2) Breaker Close Signal and outputs the (3) Breaker Closing Signal while taking into account the time that is required for the (4) Circuit Breaker to close so that the transformer re-



energizes at the controlled reference phase.

- 3). The (7) inrush current is suppressed because the (4) Circuit Breaker is closed at the controlled reference phase.

### 3- 2 Re-energizing Operation of the Transformer

- 1). When the Controller receives the close signal, as a result of manual operation on the power utility substation equipment, it references the source and transformer voltages and calculates the optimum phase angle that will dictate the breaker closing parameters. The Controller then outputs the breaker closing signal which closes the circuit breaker and re-energizes the transformer.
  - 2). The source and transformer voltages are used to calculate the actual data (operating time and closing phase angle) and voltage drop levels.
- ※ The actual data (operating time and phase angle for closing the breaker) and voltage drop levels are displayed in the Touch panel.

### 3- 3 Shutdown Operation of the Transformer

- 1). The manual operation to shutdown the transformer on the power utility substation equipment trips the circuit breaker, which thereby shuts down the transformer. The Controller references the transformer voltage before and after it is re-energized or shut down.
- 2). The referenced transformer voltage data are integrated by time to determine the fluxes and calculate the residual fluxes in the transformer core.

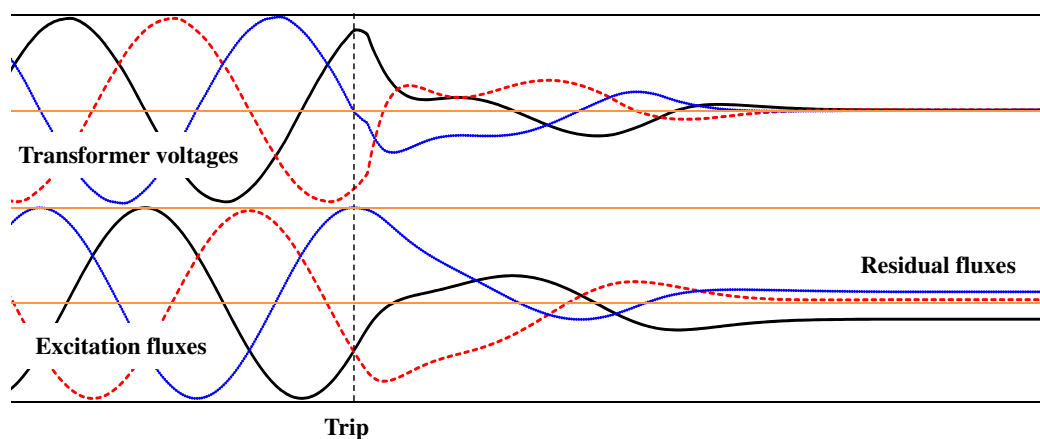

- 3). The residual fluxes are used to calculate the next control phase and the optimum phase angle at which to re-energize the transformer. The result is reflected the next time the breaker is closed.  
The circuit breaker operating time for the next closing operation is the fastest phase that was measured on the last re-energizing operation of the transformer.
- ※ The residual fluxes and closing signal data are displayed on the Touch panel on the Control Unit.

### 3- 4 Source Failure Protection (Optional)

When a source failure occurs, the Controller references the transformer voltage to determine the residual fluxes.

The next time the transformer is re-energized, the Controller uses the optimum phase angle that was determined from the residual fluxes to control the circuit breaker, which thereby suppresses inrush current.

The following timing chart shows how the Inrush Limiter operates during a source failure.

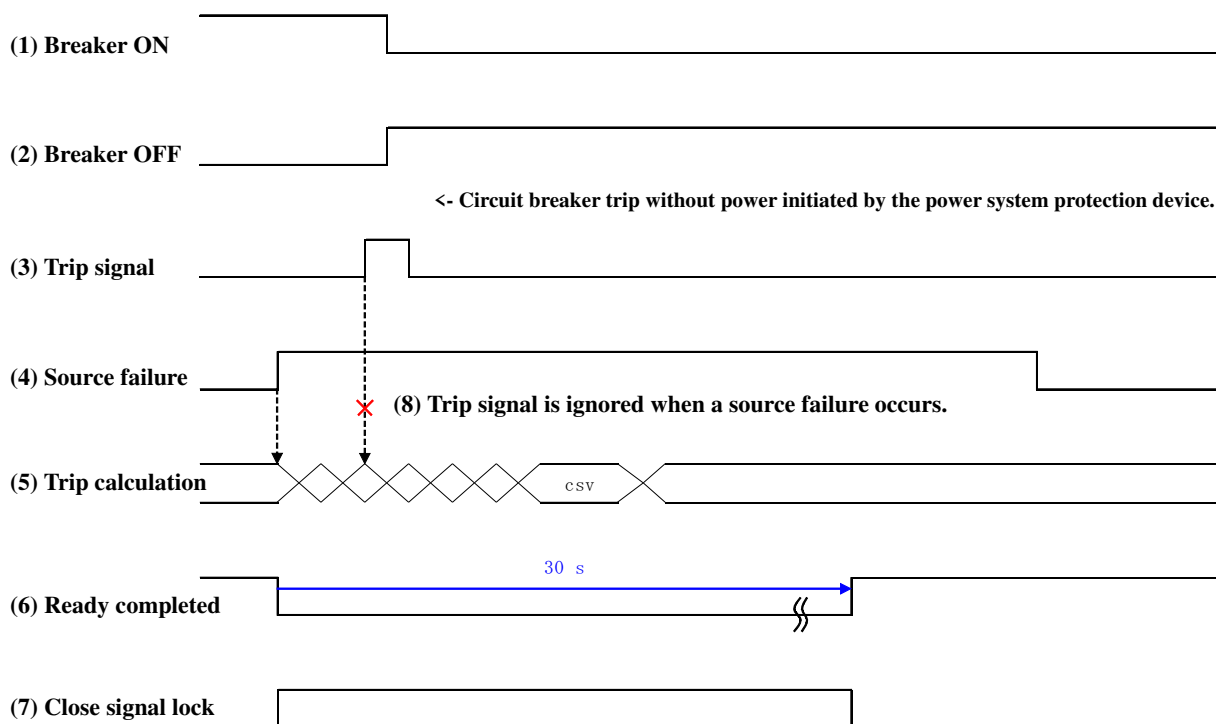

1). If a (4) Source Failure occurs when the (1) Breaker is in the ON state, the (6) Ready Completed indicator goes out and the (7) Close Signal Lock turns ON. The (5) Trip Calculation processing calculates the residual fluxes and optimum controlled phase angle.

2). When a (4) Source Failure occurs, the circuit breaker that is associated with the Inrush Limiter could trip in the absence of power. To prevent this trip from triggering the (5) Trip Calculation, the (3) Trip Signal is ignored if the (4) Source Failure is active, so that data is not overwritten.

3). After 30 seconds from the (4) Source Failure, the (6) Ready Completed indicator turns ON and the (7) Close Signal Lock deactivates. The Controller resumes its state of readiness to suppress inrush currents the next time the circuit breaker is closed.

Chaptear 4. Product Specifications

The following table gives the product specifications.

|                                      |           | Control Unit   | I/O Unit   |
|--------------------------------------|-----------|--|--|
| Model Number                         |           | IL-CU210   | IL-IO-DC110  |
| Mounting System                      |           | Rack or panel  |  |
| Outline Dimensions<br>W x H x D [mm] |           | 318 × 266 × 360<br>Not including projections such as terminal blocks   | 318 × 133 × 360<br>Not including projections such as terminal blocks |
| Paint Color                          |           | Silver colored anodized aluminum   |  |
| Mass weight [kg]                     |           | 9  | 7  |
| Power Supply Voltage                 |           | Supplies power from the I/O Unit.  | 100 VDC (90 to 120 VDC), 200 W or 1250 VDC (100 to 135 VDC), 200 W   |
| CPU                                  | OS        | RedHawk Linux  | —  |
|                                      | Processor | Atom E3845 1.91GHz<br>Calendar backup battery life : 10 years  | —  |
|                                      | Memory    | 2GB  | —  |
| Touch panel                          |           | 5.7 Inch(QVGA)<br>Number of color : 65,536<br>Back lit life : 50,000hours<br>Touch panel life : 1 million times  | —  |
| Communications                       |           | Supports a PC for maintenance<br>Ethernet100Base-T or higher   |  |
| Cooling System                       |           | Natural cooling  |  |
| Ambient Temperature and Humidity     |           | -20 to 60deg.C (no freezing), 20 to 90% (not dew)  |  |
| Ambient operating conditions         |           | Avoid installation in areas where toxic, explosive, or otherwise hazardous smoke or gases exist. Also avoid areas subject to excessive dust, particulate matter, vibration, or shock. Make sure there are no obstructions to the flow of heated air.                           |  |
| Dielectric Voltage                   |           | -  | 2000 VAC for one minute, (all input terminals to ground).            |
| Other services                       |           | Planning consultation, customer-specific requirements, panel production, factory acceptance testing<br>Unit installation, wiring works, on-site testing<br>Maintenance and inspections, Software Tool, communications cables<br>PC for maintenance, inspections, and servicing |  |



- Please do not measure insulation resistance and withstand voltage test. Includes a weak electric circuit (only the target circuit has been implemented at the time of shipment).

Chapter 5. I/O specifications

5- 1 Input Terminals (TB1) Mounted on the Control Unit

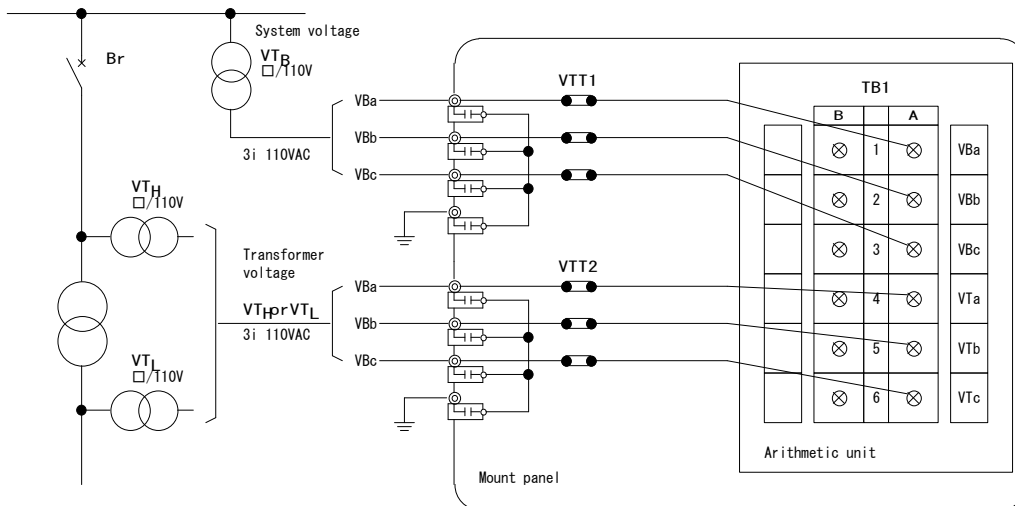

※ TB1 of column A and jumper bracket between the B columns are connected. Do not remove.

| # | Signal               | Terminals    | Input from  | Specifications |
|---|----------------------|--------------|---|----------------|
| 1 | Power system voltage | TB1—A1,A2,A3 | Secondary VT voltages on primary side of customer's circuit breaker   | 3 phase, 110 V |
| 2 | Transformer voltage  | TB1—A4,A5,A6 | Secondary VT voltages (high voltage or low voltage side of transformer) on secondary side of customer's circuit breaker | 3 phase, 110 V |

- ※ Test terminals should be furnished on the input terminals for VT voltages.
- ※ If input circuits are also connected to outdoor devices, furnish surge noise protection by connecting a terminal block with a capacitor (rated for 1500 VDC, static capacity 0.5 μF).

5-2 Input Terminals (X1) Mounted on the Operation Unit

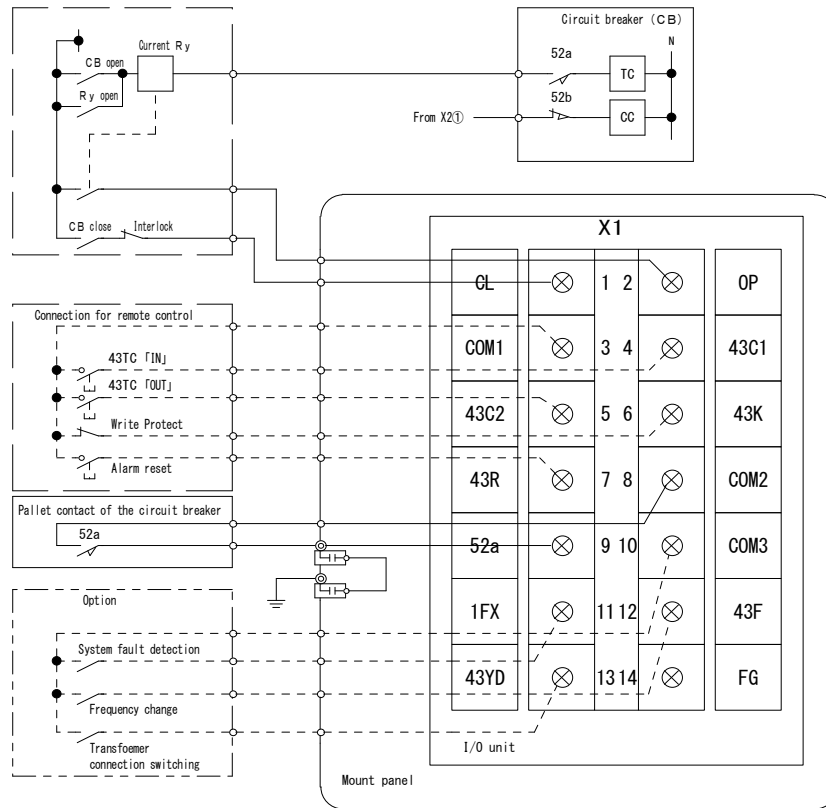

| # | Signal                 | Terminals | Input from   | Input Specifications              |
|---|------------------------|-----------|--|-----------------------------------|
| 1 | Breaker trip signal    | X1-2      | Connect the contacts of a current relay which is added to the output end of the circuit breaker tripping circuit.  | 110 VDC, 5mA                      |
| 2 | Breaker close signal   | X1-1      | Output end of the customer's circuit breaker close circuit.  | 110 VDC, 19mA                     |
| 3 | Circuit breaker status | X1-8,9    | Palette contacts of the circuit breaker  | Dry contacts 1 NO<br>110 VDC 10mA |
| 4 | Write protect          | X1-3,6    | Circuit breaker primary side auxiliary contact   | Dry contacts 1 NC<br>110 VDC 5mA  |
| 5 | Alarm reset            | X1-3,7    | Momentary-switch contact for alarm reset operation   | Dry contacts 1 NO<br>110 VDC 5mA  |
| 6 | Control mode selector  | X1-3,4,5  | Contacts for a momentary switch used for toggling.<br>*Use to enable/disable remote control of the Inrush Limiter. | Dry contacts<br>110 VDC 5mA       |
| 7 | Line failure           | X1-10,11  | Contacts from a relay (mounted in the cabinet) for line failure detection. Contact us more detail.                 | Dry contacts<br>110 VDC 5mA       |
| 8 | Frequency change       | X1-10,12  | Contacts from a relay (mounted in the cabinet) for frequency change. Contact us more detail.                       | Dry contacts<br>110 VDC 5mA       |
| 9 | Transformer connection | X1-10,13  | Contacts from a relay (mounted in the cabinet) for transformer connection. Contact us more detail.                 | Dry contacts<br>110 VDC 5mA       |

※ If input circuits are also connected to outdoor devices, furnish surge noise protection by connecting a terminal block with a capacitor (rated for 1500 VDC, static capacity 0.5 μF).

5-3 Output Terminals (X2) Mounted on the Operation Unit

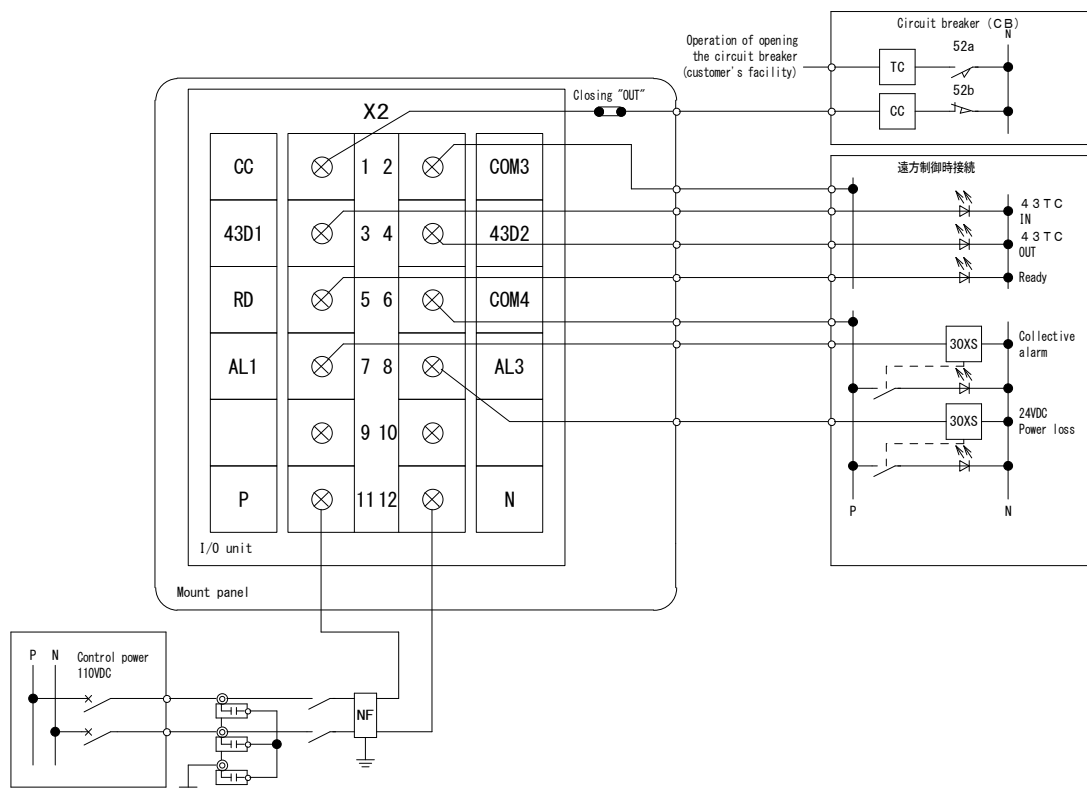

| # | Signal       | Terminals | Input from  | Specifications       |
|---|--------------|-----------|---|----------------------|
| 1 | Power source | X2—11, 12 | Power source should be same as customer's equipment | 110V/125V DC<br>200W |

※ If not 110V DC, please contact us.

| # | Signal                 | Terminals | Output to   | Output specifications                    |
|---|------------------------|-----------|---|--|
| 1 | Closing signal         | X2—1      | Receiver of closing signal from the circuit breaker.  | 110 VDC, 10A maximum                     |
| 2 | Control mode indicator | X2—2,3,4  | Indicator circuits on power utility substation equipment.<br>*Use to enable/disable remote control of the Inrush Limiter. | Dry contacts<br>110 VDC 2A               |
| 3 | Ready completed        | X2—2,5    | Indicator circuits on power utility substation equipment.   | Dry contacts<br>110 VDC 2A<br>/220VAC 1A |
| 4 | Alarm outputs          | X2—6,7,8  | Alarm circuits on power utility substation equipment.   |  |

※ If input circuits are also connected to outdoor devices, furnish surge noise protection by connecting a terminal block with a capacitor (rated for 1500 VDC, static capacity 0.5 μF).

Chaptear 6. Standard Cabinet Specifications

In addition to the individual units, we also can provide standard cabinets for mounting the Inrush Limiter units.

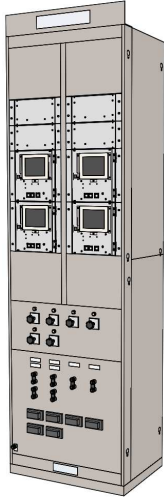
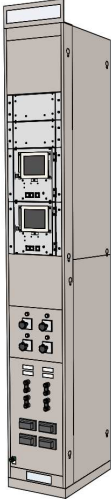
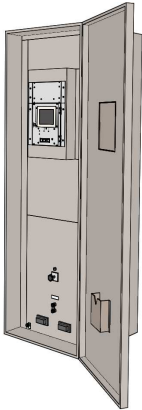
| 4 Banks (Model: IL-EC04-*)  | 2 Banks (Model: IL-EC02-*)   |
|---|--|
|    |   |
| <ul style="list-style-type: none"> <li>- Frame with four mounting banks (Front and rear accessible)</li> <li>- 700 x 2,300 x 450 mm (W x H x D) (Except channel and manufacture nameplate)</li> </ul> | <ul style="list-style-type: none"> <li>- Frame with two mounting banks (Front and rear accessible)</li> <li>- 350 x 2,300 x 450 mm (W x H x D) (Except channel and manufacture nameplate)</li> </ul> |
| <p>Cabinet with front door (Model: IL-EC01-1)</p>   | <p>Build to order (Model: IL-ECX-*)</p>  |
|    | <p>* We offer build-to-order models according to customer specifications.</p>  |
| <ul style="list-style-type: none"> <li>-Frame with one mounting bank (Front accessible)</li> <li>- 700 x 2,300 x 600 mm (W x H x D) (Except channel and manufacture nameplate)</li> </ul>             |  |

| # | Panel type           | No. of banks | Mounted devices   | Maintenance              | External connections                     |
|---|----------------------|--------------|---|--------------------------|--|
| 1 | 4-Bank model         | 1 to 4       | <ul style="list-style-type: none"> <li>- Power switch</li> <li>- Voltage input test terminals</li> <li>- Test terminal for close locking</li> </ul> | Access at front and rear | Terminals on rear side, bottom of panel. |
| 2 | 2-Bank model         | 1 to 2       |   | Access at front          | Terminals on bottom of panel.            |
| 3 | Front door model     | 1            | <ul style="list-style-type: none"> <li>- Terminals with capacitors</li> </ul>   | —                        | —  |
| 4 | Build-to-order model | —            |   |                          |  |

※ Specifications and installation conditions must be discussed for build-to-order models.

## Chapter 7. PC for Maintenance and Indicators

### 7- 1 PC for Maintenance

You can use a PC for maintenance by installing the Software Tool. This allows you to make various settings, and manage the operation of the circuit breaker for re-energizing the transformer. The PC is not necessary to perform normal operation of the equipment.

The Software Tool Installation CD is supplied with the Inrush Limiter.

1). Initial equipment settings

This screen allows you to make various settings and changes related to the transformer.

2). Log management

This screen displays up to 100 events of the most recent trip/close operations of the circuit breaker. Use this to keep track of the operation of the circuit breaker.

The log can be exported as a CSV file.

3). Voltage drop graphs

This screen displays a graph of the voltage drop when the transformer is re-energized.

4). Residual flux graph

This screen displays the residual flux when the transformer is disconnected in a graph.

5). Manual control settings

This screen allows you to set manual control parameters for the breaker closing signal.

By default, the screen shows the optimum values for closing the breaker. These can be changed as desired by entering a new value.

These screenshots are for items 1 to 4, as described above.

Initial settings

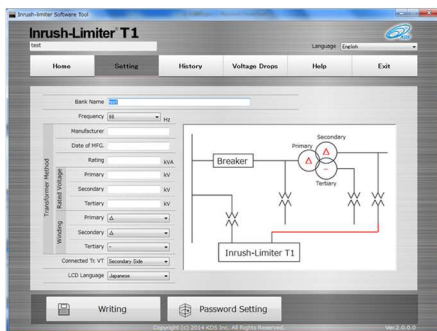

Log display

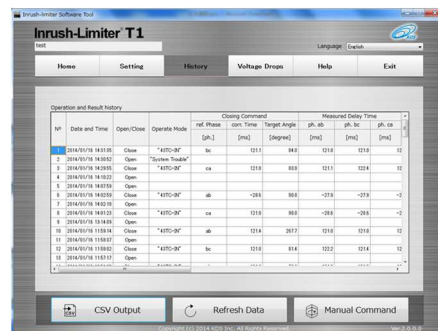

Voltage drop graph

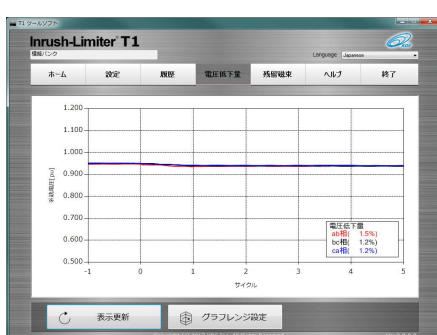

Residual flux graph

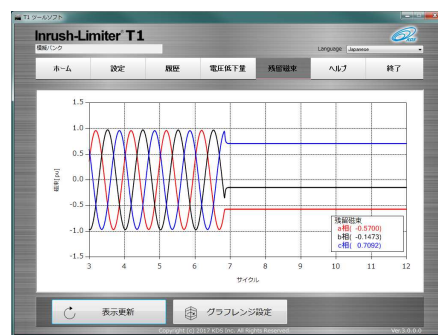



7-2 Touch panel

The following items are displayed on the touch panel for the results of circuit breaker operation.

- 1). Data at trip (Residual fluxes, command of close)
- 2). Data at close (Time for close, Closing phase angle, Voltage drop)
- 3). Operation history (history data at trip and close, less than 100 history data)
- 4). Graph (Residual fluxes graph)
- 5). Log (Time of alarm and return)
- 6). Language (English or Japanese)

The screenshots for items 1 to 6 are shown in below.

Data at trip

| Trip Data     |         | Inrush-Limiter T1 |         |  |
|---------------|---------|-------------------|---------|--|
|               | Phase-a | Phase-b           | Phase-c |  |
| Residual Flux | -0.4662 | 0.6902            | -0.2181 |  |
|               | Phase   | Delay             | Angle   |  |
| Control Value | a       | 129.4 ms          | 77.4°   |  |

Close Data    Back

Data at close

| Close Data   |          | Inrush-Limiter T1 |          |  |
|--------------|----------|-------------------|----------|--|
|              | Phase-a  | Phase-b           | Phase-c  |  |
| Actual Delay | 130.4 ms | 129.4 ms          | 129.4 ms |  |
| Actual Angle | 317.4°   | 197.4°            | 77.4°    |  |
| Voltage Sag  | 3.1%     | 3.6%              | 3.6%     |  |

Trip Data    Back

Operation history

| History  |       | Inrush-Limiter T1 |  |
|----------|-------|-------------------|--|
| Date     | Time  | 残留磁束a相            |  |
| 17/05/20 | 12:04 | 0.1234            |  |
| 17/05/20 | 12:03 | 0.1234            |  |

17/05/20 (Sat) 12:05    Back

Graph

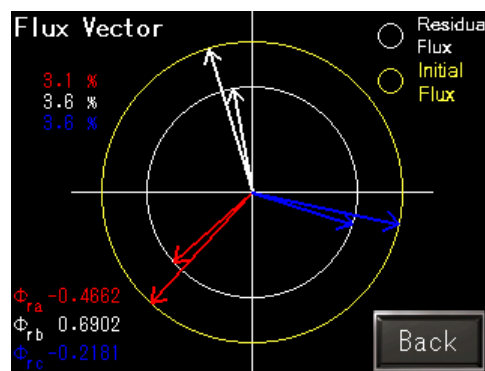

Log

| Log      |       | Inrush-Limiter T1 |               |
|----------|-------|-------------------|---------------|
| Date     | On    | Off               | Log           |
| 18/03/28 | 14:53 |                   | Voltage Error |
| 18/03/28 | 14:53 |                   | CB close      |
| 18/03/28 | 14:53 | 14:53             | CB trip       |
| 18/03/28 | 14:53 | 14:53             | CB close      |
| 18/03/28 | 14:53 | 14:53             | CB trip       |
| 18/03/28 | 14:53 | 14:53             | Ready         |
| 18/03/28 | 14:53 | 14:53             | Close Signal  |
| 18/03/28 | 14:53 |                   | 43TC_OUT      |
| 18/03/28 | 14:53 | 14:53             | 43TC_IN       |

18/03/28 (Wed) 14:54    Back

Language

Language    Inrush-Limiter T1

Japanese    English

Back

Chaptear 8. Installation Notes

8- 1 Mounting Dimensions and Panel Cutouts

The mounting dimensions for the units and the panel cutouts are as shown below.

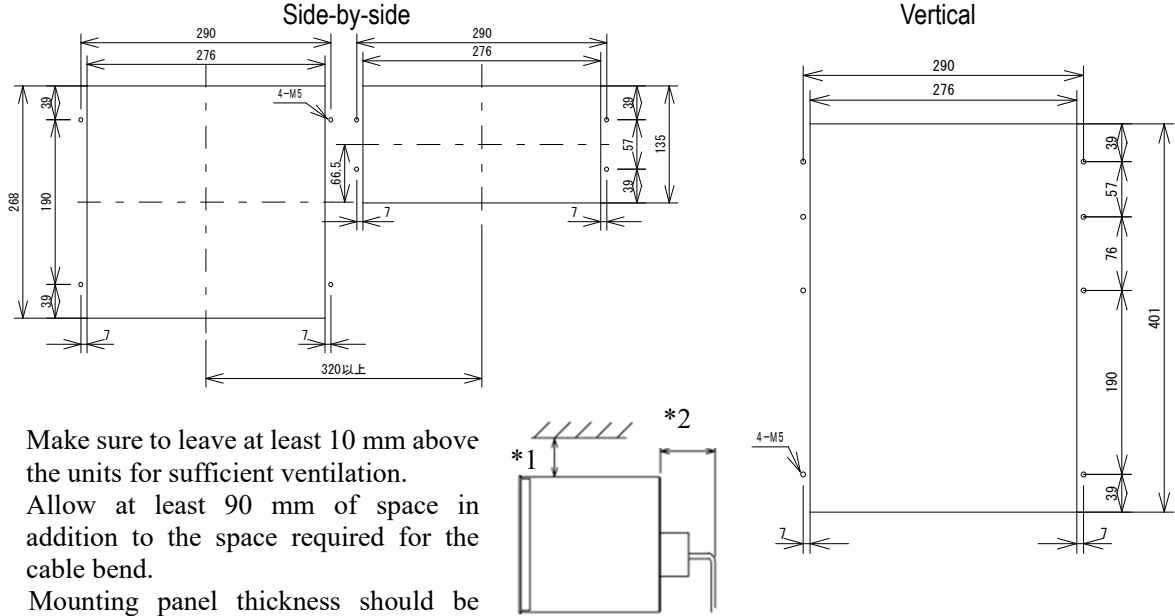

8-2 Construction

These units are built with the following features to make installation and maintenance easy.

- 1). This product can be maintained from the front, and has a structure that allows easy replacement and installation for each device.
- 2). The terminal block of this product is a connector type. Terminal block can separate external wiring without disconnecting cables.

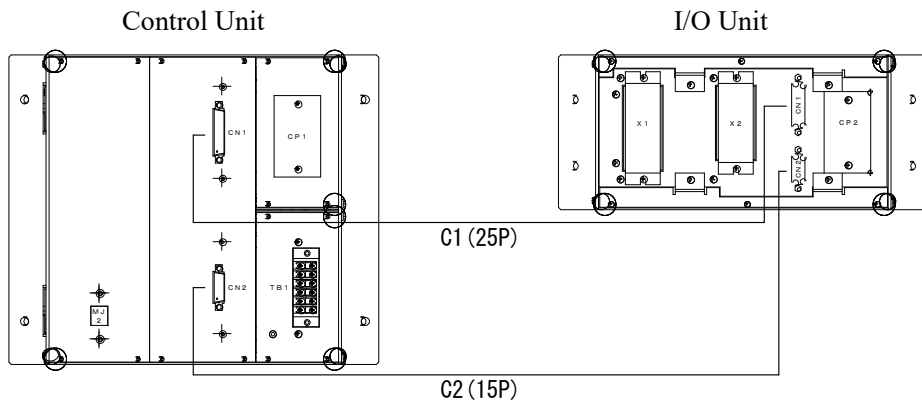

### 8-3 Wiring

- 1). Use an appropriate wire size (about 2 mm<sup>2</sup>) for connection to the terminal block, use M3.5 for the X1 and X2 terminal blocks, and use M3 for the TB1 terminal block and tighten the crimp terminals.
- 2). Refer to the wiring diagram when wiring.
- 3). Connect the control cable through the terminal block of the panel (rack mount) to which this device is mounted.
- 4). The terminal block on the back of the device is a connector type. Perform wiring with sufficient margin for maintenance.
- 5). For the control power supply, VT secondary output, and breaker pallet contact, it is recommended to install a terminal block with a 1500V DC rated voltage 5 $\mu$ F capacitance capacitor with the following specifications as a measure against surge noise.

#### **【Connection between units】**

Use the attached dedicated cable (standard length 0.5 m) for the connection between the Control unit and the I / O unit.

#### **【Connection with maintenance PC】**

Connect a LAN cable to the communication port on the front of the processing unit.

### 8-4 Inspections

- 1). Check for any loose mounting and wiring screws.
- 2). Make sure the connector leads are firmly connected on both units.
- 3). Insulation and dielectric testing is performed prior to shipment with low-voltage circuitry isolated. Do not test at site.
- 4). Make sure the phases for the source voltage and transformer voltage match.
- 5). Check all wiring according to the wiring diagram.
- 6). Before you turn ON the control power, make sure there are no short circuits or ground faults.

Chaptear 9. Testing and Adjustments

Follow the flow chart below to ensure the Inrush Limiter operates correctly.

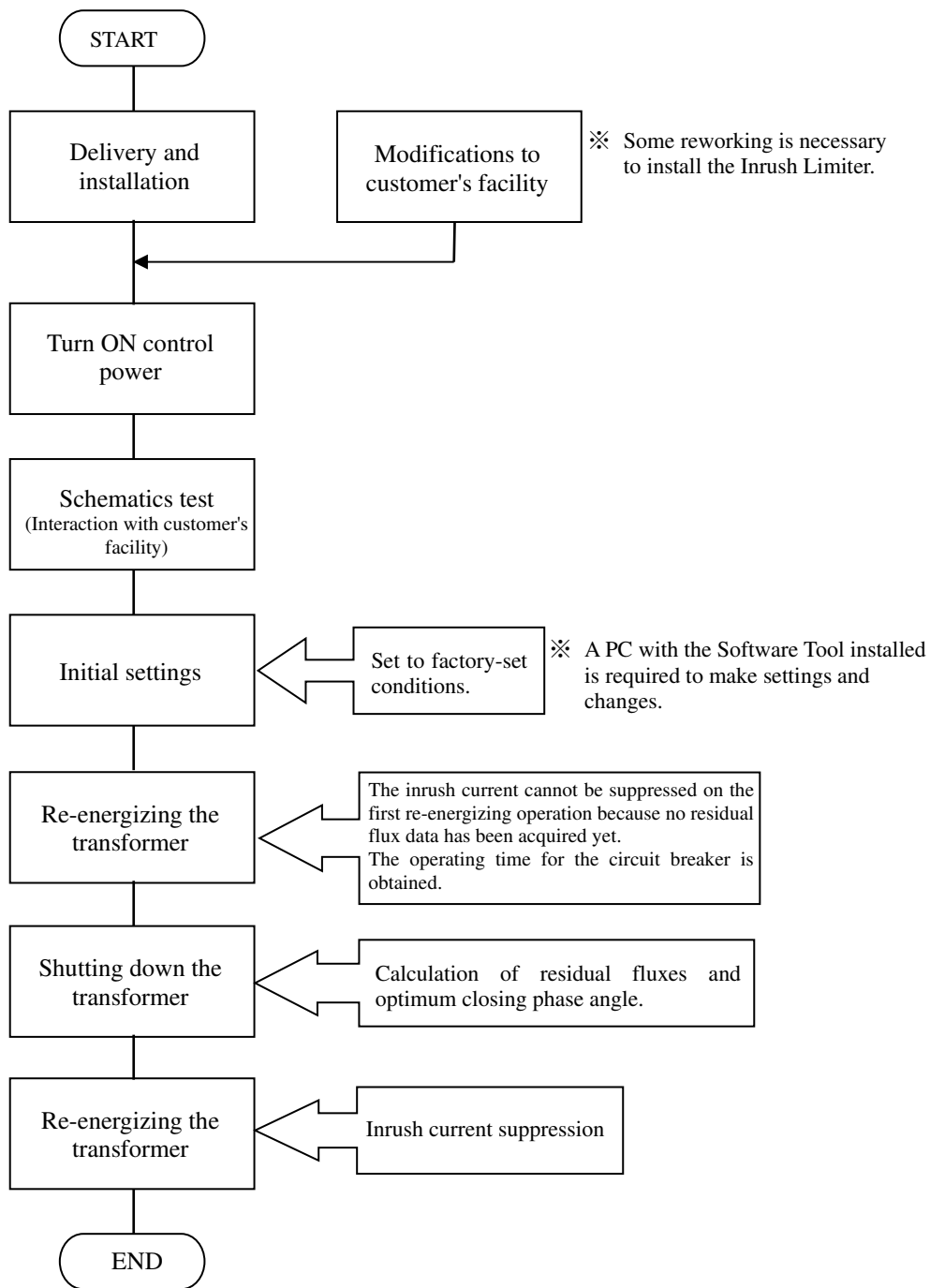

### Chapter 10. Maintenance

The Inrush Limiter is designed to be easy to maintain, with a fan-less design, and minimal moving parts and consumables.

The following section describes daily and regular inspections, and consumables.

#### 10- 1 Daily Inspections

There are no special procedures to carry out on a daily basis.

Check the alarm indicators, and for the presents of abnormal noise or odor during operation.

#### 10- 2 Regular Inspections

The purpose of regular inspections is to verify functionality and performance, and to maintain quality.

We recommend regular inspections be performed once every three years along with the scheduled maintenance for the circuit breaker and transformer.

#### 10- 3 Consumables

The Inrush Limiter uses a backup battery for its calendar. This is the only consumable item for this product.

The battery life is 10 years. The battery should be replaced regularly to ensure normal operation.

#### 10- 4 Notice

Insulation and dielectric testing is performed prior to shipment with low-voltage circuitry isolated. Do not test at site because of low voltage electrical circuits.

### Chaptear 11. Options

This section describes the product, service, and functional operations that are available for the Inrush Limiter.

#### 11- 1 Product Options

| # | Product Name                             | Description   |
|---|--|---|
| 1 | PC for Maintenance                       | This is a personal computer for setting parameters, operation logging and management, and maintenance.<br>It is loaded with the special Software Tool and comes with a LAN cable for communications.<br>* Excel and other applications for analyzing CSV data files are not included. |
| 2 | Controller battery (replacement battery) | This battery backs up the calendar in the Controller.<br>The battery life is 10 years. Contact us when the battery needs to be replaced.  |
| 3 | Display of touch panel (for replacement) | This is a replacement parts for the touch panel display.<br>Please order to us when backlight is out.   |

#### 11- 2 Service Options

| # | Service                         | Description   |
|---|---------------------------------|---|
| 1 | Installation consulting         | Our consulting produces an estimate of installation costs and the expected benefits of the Inrush Limiter based on a study of the facilities specifications. Our proposal takes into account the amount of inrush current before and after the use of our Inrush Limiter. |
| 2 | Unit installation work          | This work includes installation of the units in the customer's cabinet and all necessary wiring.  |
| 3 | Unit mounting/installation work | This service includes mounting of the units in our standard cabinet or a customer-specified cabinet. Wiring work with the customer's facilities is included.  |
| 4 | On-site testing                 | This refers to the parameter settings and testing that is performed after installation to meet the power utility substation equipment.  |
| 5 | Regular Inspections             | Regularly scheduled inspections can be provided upon request.   |
| 6 | Readjustments                   | This is an on-site service to readjust parameters and settings to meet any changes in the customer's configuration.   |
| 7 | Troubleshooting and Repairs     | If the Inrush Limiter should fail, we can provide service to investigate the cause of failure and make repairs.   |

#### 11- 3 Functional Options

| # | Product Name   | Description  |
|---|--|--|
| 1 | Frequency switching                                    | Applies when switching between 50 / 60Hz in the power supply specifications.                         |
| 2 | Transformer connection switching                       | Applicable when switching and operating Y / Δ in transformer specifications.                         |
| 3 | System side voltage single phase capture specification | Applies when the system power supply side VT for reference voltage measurement is single-phase only. |
| 4 | Single-phase transformer specification                 | Applicable when the target transformer has a single-phase specification.                             |

## Chaptear 12. Others

### 12- 1 Warranty

- 1). The Inrush Limiter is warranted for one year after delivery to the customer's specified location.
- 2). If a failure that is attributed to Kodensya occurs during the warranty period, Kodensya will replace or repair the product free of charge.
- 3). This warranty does not apply if the product fails due to:
  - ① use under inappropriate conditions, environment, handling practices, or usage procedures that are not documented in the instruction manual, or any other separately agreed upon specifications or other documentation.
  - ② problems with sources other than the product itself, such as the customer's facilities or software design.
  - ③ modifications or repairs not performed by Kodensya.
  - ④ reasons that could not be reasonably foreseen with the level of scientific and technical knowledge when the product was shipped.
  - ⑤ natural disasters such as earthquakes, lightening, or flooding, or failures caused by fire or the source power supply.
- 4). The scope of this warranty is limited to paragraph 2). Any incidental damages caused by failure of this product (i.e., equipment damages, opportunity loss, lost profit, etc.) shall be excluded from the scope of this warranty.
- 5). Refer to the warranty certificate that is included with the Inrush Limiter for further details on the warranty.

### 12- 2 Notes on Specifications

When planning the installation of the Inrush Limiter, check the following items that concern the specifications of your power utility equipment.

Some specifications may not allow the Inrush Limiter to perform correctly, or allow it to be connected.

- 1). The Inrush Limiter cannot perform control operation if the source and transformer voltages cannot be measured because it cannot determine the phase or measure the residual fluxes.
- 2). The control function will not work if the phases of the source and transformer voltages do not match.  
The phase orientation must be forward for the control function to work.
- 3). Always perform shut down and re-energize the transformer by disconnecting any loads on the secondary side of the transformer first.
- 4). The Inrush Limiter calculates the breaker operation time when the transformer is re-energized, and the residual fluxes when the transformer is tripped. This is used to perform phase angle control the next time the transformer is re-energized.

Immediately after installation, when the transformer is energized for the very first time, no residual flux data or breaker operation time has been acquired yet. Therefore, it is not possible to process phase angle control.

Chaptear 13. Typical Application Procedure

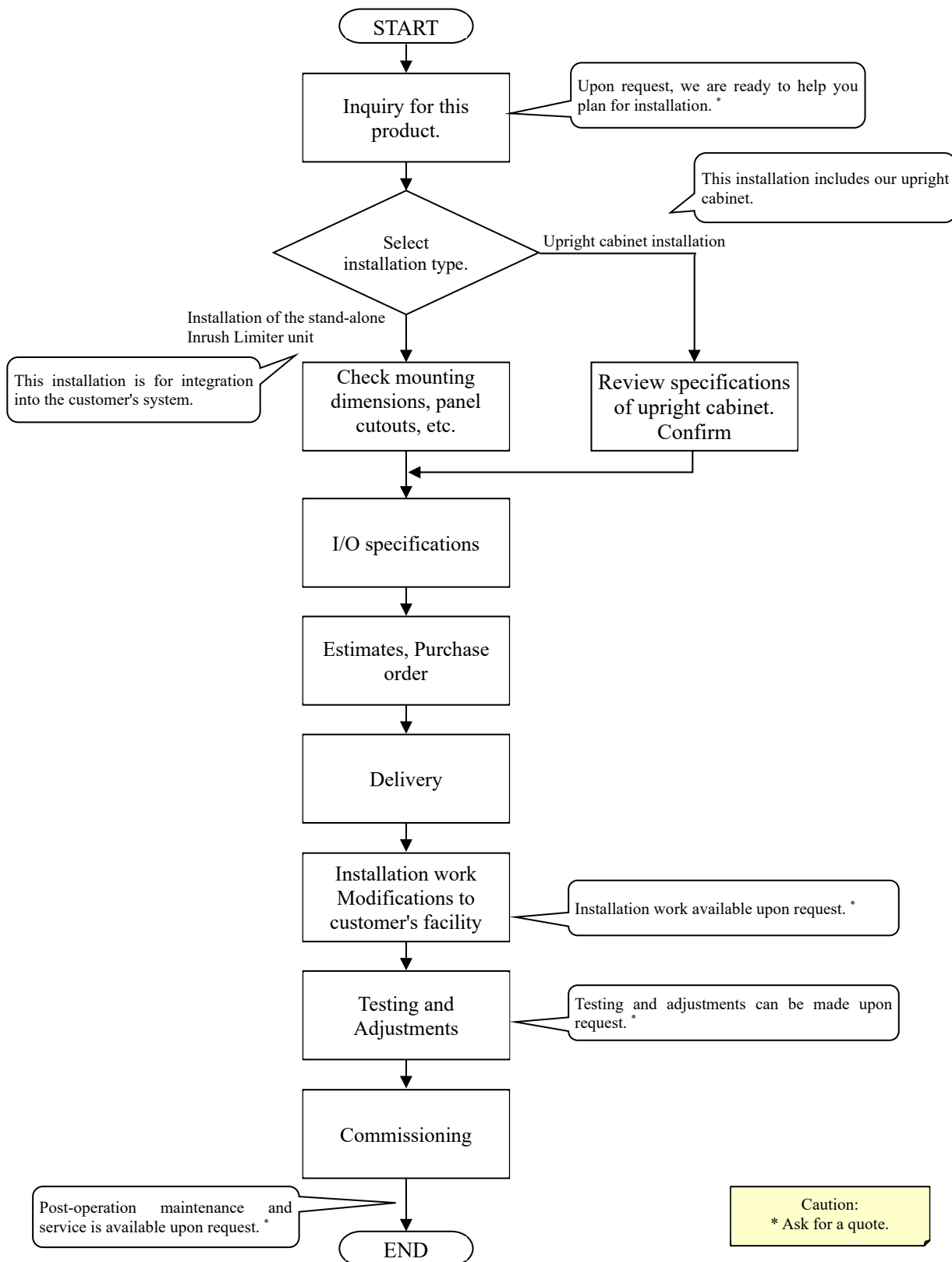



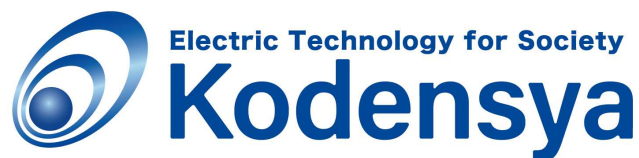

|  |   |   |
|--|---|---|
|  | <b>Safety<br/>Precautions<br/>Caution</b> | To ensure the safe and proper operation of this equipment, make sure to read the Instruction Manual prior to use. |
| - Copying of this document, in part or whole, is strictly prohibited.<br>- Due to ongoing product modifications and improvements, specifications are subject to change without notice. |   |   |

Contact a Kodensya sales representative for details on specifications or other inquiries.

**Kodensya, Co., Ltd.**

E-mail [info@kodensya.co.jp](mailto:info@kodensya.co.jp)

- Head Office : 222-1 Hamamachi, Nobeoka-shi, Miyazaki, Japan 882-0862  
Phone +81 982-33-3602, Fax +81 982-33-3684
- Miyazaki Branch: 2940-63 Aza-shimonoyama, Shimonaka, Sadowaracho,  
Miyazaki-shi, Miyazaki, Japan 880-0212  
Phone +81 985-62-7272, Fax +81 985-62-7273
- Nichinan Office: 1120-16 Ooaza-hirano, Nichinan-shi, Miyazaki, Japan 887-0015  
Phone +81 987-24-0326, Fax +81 987-24-0609
- Oita Office: 6-25 Kubarukita, Oita-shi, Oita 870-0324  
Phone +81 97-593-5012, Fax +81 97-593-5026
- Fukuoka Sales Office: 2-10-28 Isoda, Hakata-ku, Fukuoka-shi, Fukuoka 812-0881  
Office Parea Isoda II-B-1  
Phone +81 92-588-7080, Fax +81 92-588-7082

Website address <http://inrush-limiter.jp/>